

MENU MODA[®]

menu covers | table accessories | blackboards | easels





DAG STYLE, COMPANY PRODUCER OF MENU COVERS AND TABLE ACCESSORIES



Offices



Production



Showroom



DAG Style has its roots in a history of Italian design and innovation.

Menu covers and table accessories manufacturer, it combines fashion and food industry since 1989, both synonymous with quality Made in Italy recognized and appreciated all over the world. Thanks to its ecological philosophy and the desire to experiment, the company has managed to gain strong credibility among restaurateurs over the years, as well as to become a point of reference for a modern and unique style. Awarded with prizes for environmental awareness and design, the company has been able to stand out from its competitors and become a leader in the industry. DAG Style offers its products to hotels, designers, contract, and all the catering related organizations in Italy and Europe.

WHY CHOOSE A DAG STYLE MENU COVER

" DAG Style is partner in restaurants's communication with the creation of support designed to excite those who choose their local. The functional and discreet design of the DAG Style menu holders is guided by a continuous search for the properties offered by eco-sustainable materials. Attention to details and inspiration to fashion tell the quality and enthusiasm that every restaurant owner puts into his work. "



Diego Angelo Guerini
President



FSC Forest Stewardship Council

THE MOST GRAPHIC

Give maximum visibility to your restaurant with the standard graphics of the new CUSTOM MENUS or choose to customize them with your own logo.



LIKE JEANS LABELS

DAG Style reinvents the material used for jeans labels in the "CUSTOM" eco-menu collection. The cellulose fiber used for the cover is easily washable and has characteristics of high resistance for an ecological, stylish and light weight menu cover.

The optimized design for the most common paper formats and the simplicity in adding or replacing the inner envelopes, allows to have a functional menu cover respecting the environment.

- Suitable for a low intensity use.
- Soft cover, light weight, material texture.

TECHNICAL FEATURES (from 0 to 100)

Washability	79 (washable with water and neutral soap).
Anti-stain	20 (low resistance to stains).
Mechanical Strength	50 (Tear-resistant, but not to cutting).
Light Resistance	80 (average resistance to sunlights).
Sustainability	98 (cover in 100% ecological material, recyclable inner envelopes).



CELLULOSE FIBER

Composed of a mixture of raw materials deriving from secondary production processes of the paper industry (virgin cellulose, secondary fibers, synthetic and natural latexes). All the virgin cellulose used comes from companies with FSC (Forest Stewardship Council) certification.



CUSTOM ZEN



mod. A4
cod. COA43NM

mod. 4RE
cod. CO4R3NM

mod. GOLFO
cod. COGO3NM

CUSTOM COUNTRY

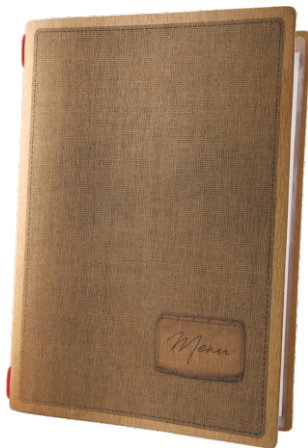

mod. A4
cod. COA43CM

mod. 4RE
cod. CO4R3CM

mod. GOLFO
cod. COGO3CM

CUSTOM MAIOLICA



mod. A4
cod. COA43MM

mod. 4RE
cod. CO4R3MM

mod. GOLFO
cod. COGO3MM

CUSTOM TATTOO



mod. A4
cod. COA43TM

mod. 4RE
cod. CO4R3TM

mod. GOLFO
cod. COGO3TM

CUSTOM ECO-DESIGN



mod. A4
cod. COA43EM

mod. 4RE
cod. CO4R3EM

mod. GOLFO
cod. COGO3EM

CUSTOM
STREETART



mod. A4
cod. COA43SM

mod. 4RE
cod. CO4R3SM

mod. GOLFO
cod. COGO3SM

CUSTOM
ROSSO PIZZA



mod. A4
cod. COA43P2M

mod. 4RE
cod. CO4R3P2M

mod. GOLFO
cod. COGO3P2M

CUSTOM
CHICAGO



mod. A4
cod. COA43P3M

mod. 4RE
cod. CO4R3P3M

mod. GOLFO
cod. COGO3P3M

Menu cover in natural cellulose fiber.

Resistant, light and eco friendly, the CUSTOM menu brings the latest graphic trends to the table. It is also possible to print your own logo directly on the cover to communicate the identity of your restaurant to the customer. An innovative system that combines the color of the print with the natural background to make the menu cover an original piece.

2 ENVELOPES

+ RED
ELASTIC CORD
max 8 envelopes

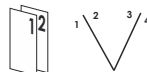
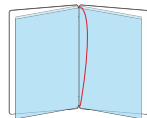

for 2 sheets 4 sides

models:

A4
€ 11,90
cm 23,2x31,8



4RE
€ 10,50
cm 17,3x31,8



GOLFO
€ 9,50
cm 16,5x23,1



CUSTOM TATTOO BLACK



mod. A4
cod. COA437M

mod. 4RE
cod. CO4R37M

mod. GOLFO
cod. COGO37M

CUSTOM SIGN

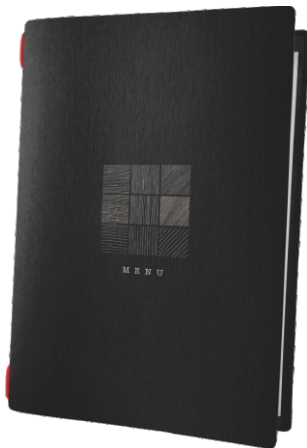

mod. A4
cod. COA432M

mod. 4RE
cod. CO4R32M

mod. GOLFO
cod. COGO32M

CUSTOM SET



mod. A4
cod. COA434M

mod. 4RE
cod. CO4R34M

mod. GOLFO
cod. COGO34M

CUSTOM DINNER



mod. A4
cod. COA433M

mod. 4RE
cod. CO4R33M

mod. GOLFO
cod. COGO33M

CUSTOM NETTUNO



mod. A4
cod. COA431M

mod. 4RE
cod. CO4R31M

mod. GOLFO
cod. COGO31M

CUSTOM BACCO

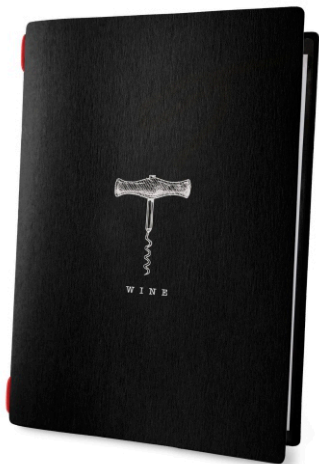

mod. A4
cod. COA436MENG

mod. 4RE
cod. CO4R36MENG

mod. GOLFO
cod. COGO36M

CUSTOM NAPOLI



mod. A4
cod. COA4310M

mod. 4RE
cod. CO4R310M

mod. GOLFO
cod. COGO310M

CUSTOM MOVIDA

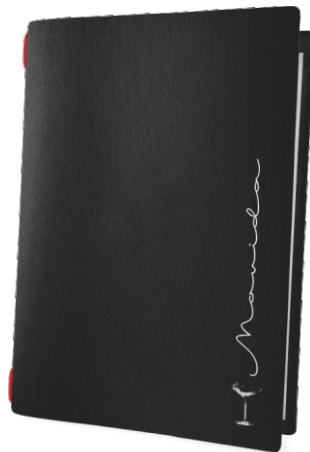

mod. A4
cod. COA439M

mod. 4RE
cod. CO4R39M

mod. GOLFO
cod. COGO39M

The contrast of the white writing chalk effect, on the back cellulose fiber, conveys the pleasant sensation of genuine quality and attention to details; the same emotions that you want to encourage in serving the courses.

This menu cover represents the best meeting point between the characteristics of resistance and lightness, washability and resistance to stains, innovative design and timeless elegance.

inners:

2 ENVELOPES

+ RED
ELASTIC CORD
max 8 envelopes

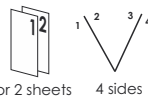
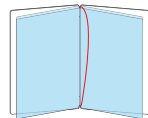

for 2 sheets 4 sides

models:

A4
€ 12,90
cm 23,2x31,8



4RE
€ 11,50
cm 17,3x31,8



GOLFO
€ 10,50
cm 16,5x23,1



GRAPHICS FOR CUSTOM "PREMIUM"

CUSTOM DAMASCO

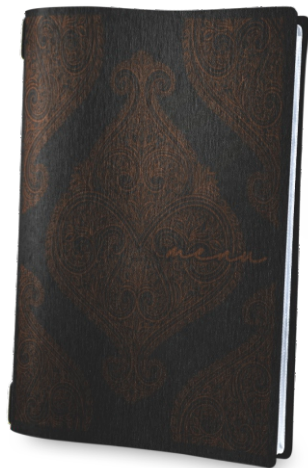

MENU WRITING

mod. A4
cod. COA43P5M

mod. 4RE
cod. CO4R3P5M

mod. GOLFO
cod. COGO3P5M

WINE WRITING

mod. A4
cod. COA43P5VENG

mod. 4RE
cod. CO4R3P5VENG

mod. GOLFO
cod. COGO3P5VENG

CUSTOM BAROCCO



MENU WRITING

mod. A4
cod. COA43P1M

mod. 4RE
cod. CO4R3P1M

mod. GOLFO
cod. COGO3P1M

WINE WRITING

mod. A4
cod. COA43P1VENG

mod. 4RE
cod. CO4R3P1VENG

mod. GOLFO
cod. COGO3P1VENG

CUSTOM SUITE

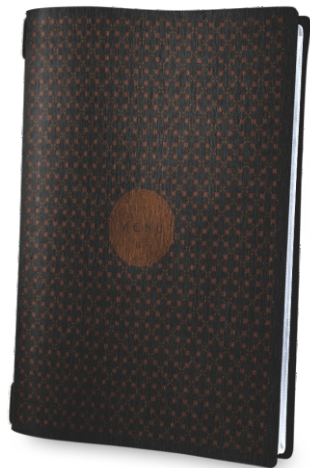

MENU WRITING

mod. A4
cod. COA43P7M

mod. 4RE
cod. CO4R3P7M

mod. GOLFO
cod. COGO3P7M

WINE WRITING

mod. A4
cod. COA43P7VENG

mod. 4RE
cod. CO4R3P7VENG

mod. GOLFO
cod. COGO3P7VENG

CUSTOM ETNO

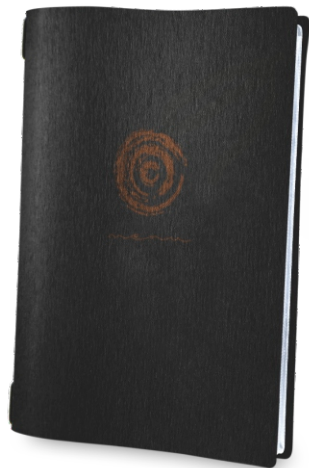

MENU WRITING

mod. A4
cod. COA43P8M

mod. 4RE
cod. CO4R3P8M

mod. GOLFO
cod. COGO3P8M

WINE WRITING

mod. A4
cod. COA43P8VENG

mod. 4RE
cod. CO4R3P8VENG

mod. GOLFO
cod. COGO3P8VENG

inners:

2 ENVELOPES

+BLACK
ELASTIC CORD
max 8 envelopes

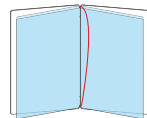

for 2 sheets 4 sides

models:

A4
€ 13,90
cm 23,2x31,8



4RE
€ 12,50
cm 17,3x31,8



GOLFO
€ 11,50
cm 16,5x23,1





The bronze-effect graphic, printed on the black cellulose fiber, creates a contrast of discreet and at the same time precious and elegant reflections. An ecological and original idea to represents the quality and attention to details of your restaurant. Also available with the words "wine" for a prestigious coordinated!



Forest Stewardship Council

THE MOST ECOLOGICAL

WHEN DESIGN MEETS THE NATURE

DAG Style reinvents the material used for the JEANS labels and proposes a revolutionary collection, sensitive to the theme of the environment, with an evocative name: ECOMODA. This material consists mainly of cellulose and boasts characteristics of high lightness and strength. With 3 color variations that recall the nuances of the earth, ECOMODA show that respect for the environment can also be a fashionable choice!

- Suitable for a low intensity use.
- Soft cover, light weight, material texture.

TECHNICAL FEATURES (from 0 to 100)

Washability	90 (washable with water and neutral soap).
Anti-stain	20 (low resistance to stains).
Mechanical Strength	70 (Tear-resistant, but not to cutting).
Light Resistance	85 (average resistance to sunlights).
Sustainability	99 (cover in 100% ecological material, recyclable inner envelopes).



CELLULOSE FIBER

Composed of a mixture of raw materials deriving from secondary production processes of the paper industry (virgin cellulose, secondary fibers, synthetic and natural latexes). All the virgin cellulose used comes from companies with **FSC** (Forest Stewardship Council) certification.



ECO MODA
BROWN

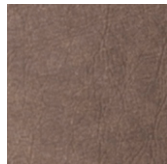

mod. A4
cod. E3A44ZE
mod. 4RE
cod. E34R4ZE
mod. GOLFO
cod. E3GO4ZE
mod. QUADRATO
cod. E3QU4ZE

ECO MODA
BLACK

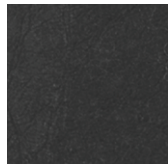

mod. A4
cod. E3A44XE
mod. 4RE
cod. E34R4XE
mod. GOLFO
cod. E3GO4XE
mod. QUADRATO
cod. E3QU4XE

ECO MODA
NATURAL

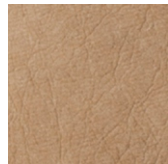

mod. A4
cod. E3A44NE
mod. 4RE
cod. E34R4NE
mod. GOLFO
cod. E3GO4NE
mod. QUADRATO
cod. E3QU4NE

inners:

4 ENVELOPES

+ BLACK
ELASTIC CORD
max 10 envelopes

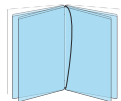

for 4 sheets



8 sides

models:

A4
€ 18,90
cm 23,2x31,8



4RE
€ 16,90
cm 17,3x31,8



GOLFO
€ 16,90
cm 16,5x23,1



QUADRATO
€ 18,90
cm 23x23,1



Menu cover in natural, washable, resistant, light and ecological cellulose fiber. Possible customization on the black "PATCH" labels with white logo print. Standard version with four inner envelopes and elastic binding.



PATCH "menu"

PATCH labels are made of black cellulose fiber, the same used for jeans labels. This label fully represents the green philosophy of DAG Style. It comes in the standard version with "menu" writing.



PATCH personalized

The PATCH version labels in black cellulose fiber are printed in 1 color (white) which allows good visibility and a high contrast.



THE MOST
RESISTANT TO WEAR

ANTIBACTERIAL MENU COVER

This line of menu covers in PVC Made in Italy, printed with a JUTA effect finish and with antibacterial certification, brings to the table an innovative menu with exceptional resistance characteristics. DAG Style offers an assortment of "fashion" colors to mix, for an eclectic and unconventional table

- Suitable for very intense use.
- Soft cover, medium weight, JUTA effect texture.

TECHNICAL FEATURES (from 0 to 100)

Washability	90 (antibacterial treatment, washable with water and neutral soap).
Anti-stain	85 (medium-high resistance to stains).
Mechanical Strength	95 (particularly resistant to wear and tear).
Light resistance	90 (medium-high resistance to sunlight)(medium for jeans color).
Sustainability	50 (cover and recyclable inner envelopes).



The word "ANTIBACTERIAL" refers to the particular treatment to which the material has been subjected. Following the microbiological analysis against the main pathogens of the food industry, no bacterial / fungal growth was detected on the treated material, unlike the articles NOT treated. The results obtained certify our article as "coating material with antimicrobial action".



COLORS AND JUTE MODELS

inners:

4 ENVELOPES
+ RED
ELASTIC CORD
max 16 envelopes

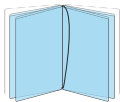

for 4 sheets



8 sides

models:

A4
€ 19,90
cm 23,2x31,8

4RE
€ 17,57
cm 17,3x31,8

GOLFO
€ 15,53
cm 16,5x23,1

QUADRATO
€ 17,84
cm 23x23,1



**JUTE
JEANS**

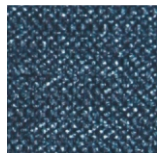

mod. A4
cod. MMA44JE
mod. 4RE
cod. MM4R4JE
mod. GOLFO
cod. MMGO4JE
mod. QUADRATO
cod. MMQU4JE



**JUTE
GREY**



mod. A4
cod. MMA44GE
mod. 4RE
cod. MM4R4GE
mod. GOLFO
cod. MMGO4GE
mod. QUADRATO
cod. MMQU4GE



**JUTE
BROWN**



mod. A4
cod. MMA44ZE
mod. 4RE
cod. MM4R4ZE
mod. GOLFO
cod. MMGO4ZE
mod. QUADRATO
cod. MMQU4ZE



**JUTE
BLACK**



mod. A4
cod. MMA44XE
mod. 4RE
cod. MM4R4XE
mod. GOLFO
cod. MMGO4XE
mod. QUADRATO
cod. MMQU4XE



**JUTE
BICOLOR**

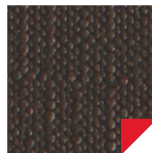

mod. A4
cod. MMA44QE
mod. 4RE
cod. MM4R4QE
mod. GOLFO
cod. MMGO4QE
mod. QUADRATO
cod. MMQU4QE

10 colors to match to invent a style. Cover with JUTA effect texture for a pleasant feel to the touch. Made of antibacterial PVC and reinforced with an internal synthetic mesh that gives it a remarkable resistance to wear over time.



**JUTE
ICE**

mod. A4
cod. MMA44WE
mod. 4RE
cod. MM4R4WE
mod. GOLFO
cod. MMGO4WE
mod. QUADRATO
cod. MMQU4WE



**JUTE
ICE BLUE**

mod. A4
cod. MMA44CE
mod. 4RE
cod. MM4R4CE
mod. GOLFO
cod. MMGO4CE
mod. QUADRATO
cod. MMQU4CE



**JUTE
GREEN**

mod. A4
cod. MMA44VE
mod. 4RE
cod. MM4R4VE
mod. GOLFO
cod. MMGO4VE
mod. QUADRATO
cod. MMQU4VE

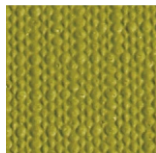

**JUTE
BLUE**

mod. A4
cod. MMA44BE
mod. 4RE
cod. MM4R4BE
mod. GOLFO
cod. MMGO4BE
mod. QUADRATO
cod. MMQU4BE



**JUTA
BURBUNDY**

mod. A4
cod. MMA44OE
mod. 4RE
cod. MM4R4OE
mod. GOLFO
cod. MMGO4OE
mod. QUADRATO
cod. MMQU4OE

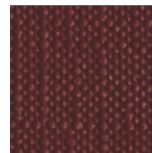

THE MOST RESISTANT TO STAINS



CHEFS CREATE EMOTIONS, DAG STYLE BRINGS THEM TO TABLE

Just as a chef would do when presenting his dishes, this menu cover line makes the list of dishes the protagonist in a sober and refined way. The material of the cover, in genuine bonded leather (material already used since 1989) is the result of a long search by DAG Style, which has managed to obtain a product that is softer to the touch but with the same resistance and washability as always. This material with anti-stain protection, strictly certified and ecological, is in fact at the top for resistance and durability. DAG Style launches the new menu cover line inspired by nature, representing it with six colors and a new "green" texture. With the new "PATCH" label in black, the "CHEF" line immediately transmits a balance between natural materials and a current design that is not taken for granted.

- Suitable for intensive use.
- Soft cover, light weight, embossed texture.

TECHNICAL FEATURES (from 0 to 100)

Washability	99 (washable with water and neutral soap).
Anti-stain	95 (anti-stain treatment).
Mechanical Strength	90 (Tear-resistant, but not to cutting).
Light Resistance	99 (color resistant to sunlights).
Sustainability	97 (cover in 100% ecological material recyclable inner envelopes).

REAL BONDED LEATHER WITH ANTI-STAIN TREATMENT



Bonded leather is made up of natural raw materials: 65% from genuine leather scraps tanned with vegetable substances, 18% from natural latex, 10% from water, 5% from natural fats and 2% from natural coloring agents.

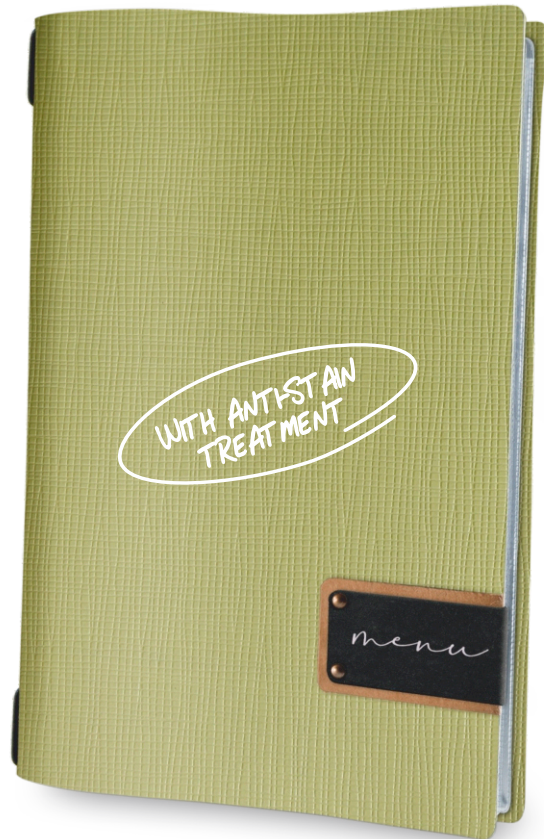

CHEF
BLACK



mod. A4
cod. F3A44XE
mod. 4RE
cod. F34R4XE
mod. GOLFO
cod. F3GO4XE
mod. QUADRATO
cod. F3QU4XE

CHEF
BROWN



mod. A4
cod. F3A44ZE
mod. 4RE
cod. F34R4ZE
mod. GOLFO
cod. F3GO4ZE
mod. QUADRATO
cod. F3QU4ZE

CHEF
GREY



mod. A4
cod. F3A44GE
mod. 4RE
cod. F34R4GE
mod. GOLFO
cod. F3GO4GE
mod. QUADRATO
cod. F3QU4GE

CHEF
BLUE

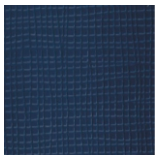

mod. A4
cod. F3A44BE
mod. 4RE
cod. F34R4BE
mod. GOLFO
cod. F3GO4BE
mod. QUADRATO
cod. F3QU4BE

CHEF
SAGE

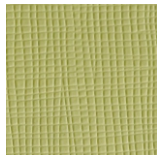

mod. A4
cod. F3A44VE
mod. 4RE
cod. F34R4VE
mod. GOLFO
cod. F3GO4VE
mod. QUADRATO
cod. F3QU4VE

CHEF
OCHER



CHEF
WHITE



CHEF
BURBUNDY

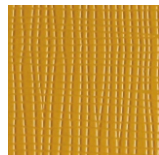

mod. A4
cod. F3A44SE
mod. 4RE
cod. F34R4SE
mod. GOLFO
cod. F3GO4SE
mod. QUADRATO
cod. F3QU4SE



mod. A4
cod. F3A44YE
mod. 4RE
cod. F34R4YE
mod. GOLFO
cod. F3GO4YE
mod. QUADRATO
cod. F3QU4YE



mod. A4
cod. F3A44OE
mod. 4RE
cod. F34R4OE
mod. GOLFO
cod. F3GO4OE
mod. QUADRATO
cod. F3QU4OE

The CHEF line, in genuine bonded leather, represents the ultimate expression of FASHION, ECOLOGY, and FUNCTIONALITY among DAG products. The superior quality raw material, the natural coloring and the stain-resistant surface protection make this line of products among the best on the market.

On light colors, particularly coloring substances can in some cases leave halos.

inners:

4 ENVELOPES

+ BLACK
ELASTIC CORD
max 16 envelopes

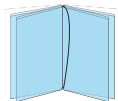

for 4 sheets



8 sides

models:

A4
€ 27,90

cm 23,2x31,8



4RE
€ 23,31

cm 17,3x31,8



GOLFO
€ 19,84

cm 16,5x23,1



QUADRATO
€ 23,58

cm 23x23,1



menucover
CORK line

THE MOST NATURAL



A NATURAL CHOICE

The menu cover that best expresses the elegance of an eco-friendly philosophy. The material, known for its characteristics of durability, hygiene and recyclability, makes it perfectly suitable for presenting the wine list, just as, thanks to its neutral color, it can be combined with any style of furniture for any type of communication.

- Suitable for intensive use.
- Soft cover, medium weight, material texture.

TECHNICAL FEATURES (from 0 to 100)

Washability	90 (washable with water and neutral soap).
Anti-stain	85 (medium-high resistance to stains).
Mechanical Strength	85 (Tear-resistant, but not to cutting).
Light resistance	60 (medium-high resistance to sunlight)
Sustainability	98 (cover in 100% in ecological material and recyclable inner envelopes).

TRUE HYGIENIC AND NATURAL CORK

The material used for the production of this menu holder line is the perfect combination of two noble elements such as **real natural cork and real leather**. The tests carried out, to define the optimal thicknesses of the overlap of cork, regenerated leather and cork, have made it possible to obtain a sought-after product that offers **high quality performance**. The external finish is obtained with a water-based treatment that makes it **refractory to stains**, and preserves the characteristics of sustainability.

inners:

4 ENVELOPES

+BLACK
ELASTIC CORD
max 16 envelopes

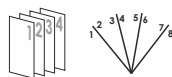
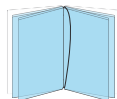

for 4 sheets

8 sides

models:

A4
€ 40,34
cod. SUA44NE
cm 23,2x31,8



4RE
€ 32,99
cod. SU4R4NE
cm 17,3x31,8



GOLFO
€ 27,45
cod. SUGO4NE
cm 16,5x23,1



QUADRATO
€ 33,26
cod. SUQU4NE
cm 23X23,1





THE MOST VALUABLE

colors

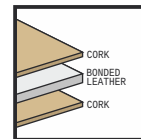

THE HIGH FASHION IN TABLE

Menu cover made with the best materials used in the world of fashion for the production of clothes and accessories.

The first choice natural cork used for this line of products has high characteristics of softness, washability and resistance to wear.

- Suitable for intensive use.
- Soft cover, medium weight, material texture.

TECHNICAL FEATURES (from 0 to 100)

Washability	90 (washable with water and neutral soap).
Anti-stain	85 (medium-high resistance to stains).
Mechanical Strength	85 (Tear-resistant, but not to cutting).
Light resistance	60 (medium-high resistance to sunlight)
Sustainability	98 (cover in 100% in ecological material and recyclable inner envelopes).

TRUE HYGIENIC AND NATURAL CORK

The material used for the production of this menu holder line is the perfect combination of two noble elements such as **real natural cork and real leather**. The tests carried out, to define the optimal thicknesses of the overlap of cork, regenerated leather and cork, have made it possible to obtain a sought-after product that offers **high quality performance**. The external finish is obtained with a water-based treatment that makes it **refractory to stains**, and preserves the characteristics of sustainability.

inners:

4 ENVELOPES

+ BLACK
ELASTIC CORD
max 16 envelopes

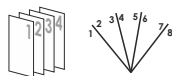
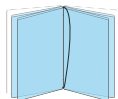

for 4 sheets

8 sides

models:

A4

€ 56,75

BLACK cod. SUA44XE
BROWN cod. SUA44ZE
cm 23,2x31,8



4RE

€ 51,27

BLACK cod. SU4R4XE
BROWN cod. SU4R4ZE
cm 17,3x31,8



GOLFO

€ 33,99

BLACK cod. SUGO4XE
BROWN cod. SUGO4ZE
cm 16,5x23,1



QUADRATO

€ 47,71

BLACK cod. SUQU4XE
BROWN cod. SUQU4ZE
cm 23x23,1





THE MOST "RUSTIC"



NORMAL THICKNESS 0.5 mm: composed of a single layer of cellulose fiber for maximum flexibility and lightness.

DOUBLE THICKNESS 1.0 mm: made by combining two layers of cellulose fiber for a more structured and resistant menu cover and with a refined aesthetic also in the internal faces.

color

brown th. 0.5/1.0

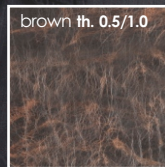

THE FASHION OF EXPERIENCE

"Living" mood and gritty style, the Vintage menu cover has a definitely strong character. Produced with the same material as jeans labels, recognized for its resistance and washability, it promises to add a personal touch to the restaurant, combining design and practice.

- Suitable for a low intensity use.
- Soft cover, light weight, material texture.

TECHNICAL FEATURES (from 0 to 100)

Washability	90 (washable with water and neutral soap).
Anti-stain	30 (low resistance to stains).
Mechanical Strength	50 (Tear-resistant, but not to cutting).
Light Resistance	70 (average resistance to sunlights).
Sustainability	98 (cover in 100% ecological material, recyclable inner envelopes).

The craftsmanship of the texture makes each product unique with different color shades.

Once washed, the color tends to darken, the veins are visible again if it is wrinkled again.

CELLULOSE FIBER

Composed of a mixture of raw materials deriving from secondary production processes of the paper industry (virgin cellulose, secondary fibers, synthetic and natural latexes). All the virgin cellulose used comes from companies with **FSC** (Forest Stewardship Council) certification.



inners:

4 ENVELOPES

+BLACK ELASTIC CORD
max 16 envelopes

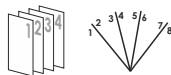
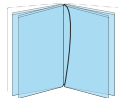

for 4 sheets

8 sides

thickness
0.5

A4
€ 28,68

cod. VIA44NE
cm 23,2x31,8

4RE

€ 24,25

cod. VIA44NE
cm 17,3x31,8

GOLFO

€ 20,89

cod. VIA44NE
cm 16,5x23,1

QUADR.

€ 24,51

cod. VIA44NE
cm 23x23,1

thickness
1.0

A4
€ 45,15

cod. V2A44NE
cm 23,2x31,8

4RE

€ 36,79

cod. V2A44NE
cm 17,3x31,8

GOLFO

€ 30,49

cod. V2A44NE
cm 16,5x23,1

QUADR.

€ 37,08

cod. V2A44NE
cm 23x23,1

models:



THE MOST SMART

secondi piatti

La bistecca di Black Angus alla fiorentina (peso 0,800 o 1,200 kg) servita con le patate cotte al forno e le verdure alla griglia (consigliato per 2 persone) 5,00 all'etto

La tartare di filetto di manzo (150 g) servita con la confettura di cipolle rosse, la senape, l'aceto balsamico, il trito di acciughe e il rosso d'uovo 18,00

L'ineguagliabile spiedone di carne e verdure di stagione cotto alla griglia con le patate al forno (consigliato per 2 persone) 29,00

Il maialino iberico con
ciola 19,00

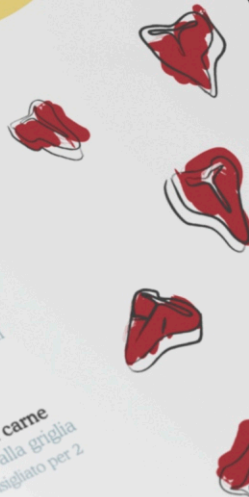

MENU NOTEPAD IN REAL BONDED LEATHER

Menu cover in genuine bonded leather with 3.5 mm thick support usually used for making belts. Flexible and soft to the touch for a fine feeling. It is further embellished with an insert in genuine 0.8 cm thick bonded leather. At the top there is a ball-point slot and in the lower part a customizable label. The simplicity of this model makes it ideal for very intense use even in extreme conditions.

- Suitable for a very intensive use.
- Semi-soft support.

TECHNICAL FEATURES (from 0 to 100)

Washability	90 (washable with water and neutral soap).
Anti-stain	99 (high resistance to stains).
Mechanical Strength	99 (maximum resistance).
Light Resistance	99 (maximum resistance to sunlights).
Sustainability	99 (cover in 100% ecological material, mechanism recyclable).

REAL BONDED LEATHER WITH ANTI-STAIN TREATMENT

Bonded leather is made up of natural raw materials: 65% from genuine leather scraps tanned with vegetable substances, 18% from natural latex, 10% from water, 5% from natural fats and 2% from natural coloring agents.



models:

A4
€ 23,91

cod. F3MB4ZE
cm 22x35,7



A5
€ 18,04

cod. F3MB5ZE
cm 16x27

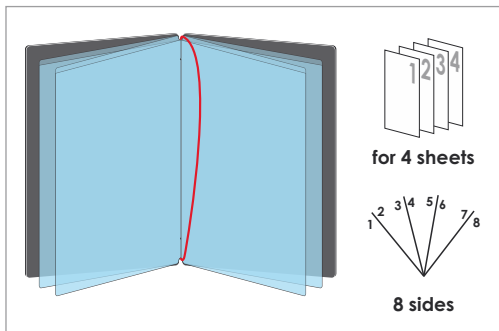

4 ENVELOPES + elastic cord (2 for CUSTOM)

DAG Style menu covers, in the standard version, are configured with 4 non-toxic certified polypropylene envelopes (2 for the CUSTOM line). The elastic binding simplifies the possible addition of additional envelopes as well as allowing the storage of simple folded sheets. This system is therefore recommended for those who frequently modify the kitchen proposals or want to organize the list in complete autonomy.



Black elastic cord



Red elastic cord

ENVELOPES SPARE PARTS box 10 pcs. (for 40 sides)

For models	For sheets	Code	Price/box
A4	21x29,7	BUXA4	€ 23,12
4RE	15,3x29,7	BUX4RE	€ 18,78
GOLFO	14,8x21	BUXGO	€ 17,34
QUADR.	21x21	BUXQU	€ 18,78

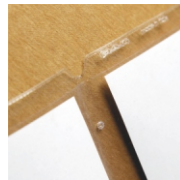
**ELASTICS SPARE PARTS** box 10 pcs. € 12,14

For models	Color	Code
A4/4RE 38 cm	black	VIE3CC
GOLFO/QUADR. 29,5 cm	black	VIE4CC
A4/4RE 38 cm	red	VIE3CR
GOLFO/QUADR. 29,5 cm	red	VIE4CR

**METAL CLIPS** box 40 pcs. € 8,78

Model	Color	Code
CLIPS open/close	bronze	CL100B
CLIPS open/close	silver	CL100G

**BIND CLAMPS** box 5 pcs. € 13,00

Model	Color	Code
29,7 cm for A4 - 4RE	black	LIBCGR
21 cm for GOLFO - QUADR.	black	LIBCGR01

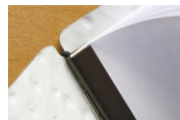

PATCH standard "menu"



PATCH labels are made of cellulose fiber, the same used for jeans labels. This label fully represents the green philosophy of DAG Style. Particularly suitable for customizations with very elaborate logos, it comes in the standard version with "menu" writing.

PATCH personalized



The "PATCH" personalized labels in cellulose fiber are printed with digital technology in 1 color (black on havana and white on black) for excellent visibility and high definition of details.



HOW TO CUSTOMIZE YOUR menu cover:

1. Provide the logo file of the logo.

The file must be of vector type (PDF, EPS, AI, CDR ...), or photo type (JPG, TIFF, PSD) if of good quality.

2. Indicate any desired variation.

Graphic elaborations for any variation € 48.00 / hour.

3. Confirm the draft.

The draft is considered approved after 24 hours from its receipt unless otherwise communicated to DAG Style.

FREE CUSTOMIZATIONS OVER 18 PIECES:

For orders below 18 pieces, fee is:

€ 87.60

(any graphic elaboration € 48,00/hour)

PERSONALIZED INSERT

"Personalized page easy to insert in the menu"



Your story, your place, your menu.

The proposals of a menu are what best represents the ideology and personality of a restaurant. DAG Style gives space to this aspect with a natural or black color cellulose fiber page, to be personalized with texts and logos, to communicate the history and philosophy that the customer is about to meet.

USE: on the first page all the space is available to insert the logo or philosophy or any text, on the other pages it is very useful to print allergens.

color	Model	Dim. side	Code	Price front	Price both sides
natural	A4	22,4x31,1	INA43NP	€ 5,41	€ 6,41
	4RE	16,5x31,1	IN4R3NP	€ 4,71	€ 5,71
	GOLFO	15,7x22,4	INGO3NP	€ 4,18	€ 5,18
	QUADR.	21,8x22,4	INQU3NP	€ 4,71	€ 5,71

color	Model	Dim. side	Code	Price front	Price both sides
black	A4	22,4x31,1	INA43XP	€ 6,67	€ 7,67
	4RE	16,5x31,1	IN4R3XP	€ 5,97	€ 6,97
	GOLFO	15,7x22,4	INGO3XP	€ 5,44	€ 6,44
	QUADR.	21,8x22,4	INQU3XP	€ 5,97	€ 6,97

FREE CUSTOMIZATIONS OVER 18 PIECES

For orders below 18 pieces,
fee is: € 87.60

(any graphic elaboration
€ 48,00/hour)

* see page 33 points 1-2-3



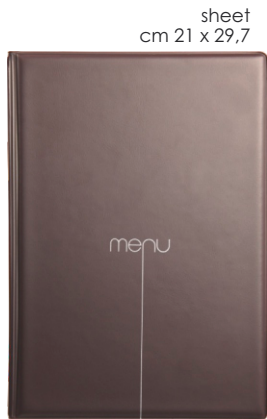

mod.
RISTO A4
€ 9,90 / pz.
(box 20 pcs.)

cod.
RIA43BM - blue
RIA43EM - red
RIA43OM - burgundy
RIA43SM - sand
RIA43XM - black
RIA43ZM - brown



mod.
RISTO A5
€ 6,80 / pz.
(box 40 pcs.)

cod.
RIA53BM - blue
RIA53EM - red
RIA53OM - burgundy
RIA53SM - sand
RIA53XM - black
RIA53ZM - brown

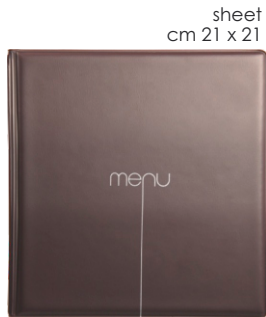

mod.
RISTO QUADRATO
€ 8,27 / pz.
(box 20 pcs.)

cod.
RIQU3BM - blue
RIQU3EM - red
RIQU3OM - burgundy
RIQU3SM - sand
RIQU3XM - black
RIQU3ZM - brown



mod.
**RISTO ORDER
HOLDER**
€ 4,90

cod.
RIPC3B - blue
RIPC3E - red
RIPC3O - burgundy
RIPC3S - sand
RIPC3X - black
RIPC3Z - brown



mod.
**RISTO BILL
HOLDER**
€ 6,90

cod.
RICO3B - blue
RICO3E - red
RICO3O - burgundy
RICO3S - sand
RICO3X - black
RICO3Z - brown

PVC conforms to EEC regulations

- menu holders **A4/A5/QUADRATO** formats
- certified **atoxic PVC**
- reinforced **double seams**
- **4 internal pockets** + 2 covers
- **smooth finish**

colors



black

cocoa

burgundy

sand

red

blue

**4 internal pockets
+2 inside
the cover**



washable

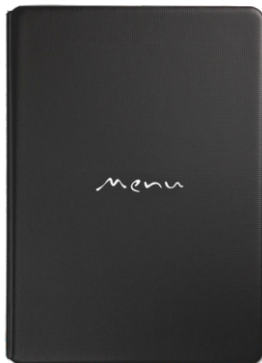

anti-stain

sheet
cm 21 x 29,7

cod. TOA4XM

mod.
**TOSCANA
A4**
€ 15,90 / pz.
(box 20 pcs.)

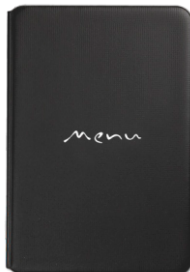
paper
cm 14,8 x 21

cod. TOA5XM

mod.
**TOSCANA
A5**
€ 10,90 / pz.
(box 40 pcs.)

sheet
cm 21 x 21

cod. TOQUXM

mod.
**TOSCANA
QUADRATO**
€ 13,37 / pz.
(box 20 pcs.)

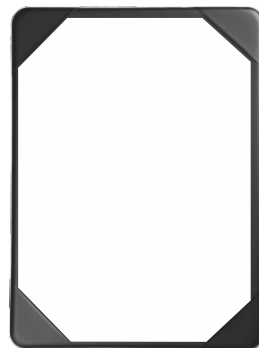
sheet
cm 21 x 29,7

cod. TOA41X

mod.
**TOSCANA
MONO ANTA A4**
€ 7,62

cm 12 x 22



cod. TOCO3X

mod.
**TOSCANA
BILL HOLDER**
€ 7,62



washable



anti-stain

color

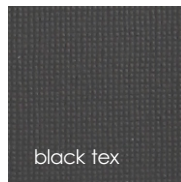

black tex

PVC conforms to EEC regulations

- menu holders **A4/A5/QUADRATO** formats
- certified **atoxic PVC**
- reinforced **double seams**
- **6 internal pockets** + 2 covers
- rough finish

**6 internal pockets
+2 inside
the cover**





RAFFAELLO

Raffaello menu boards are the perfect solutions for those searching for quality. The frame is produced completely in pine wood in a linear and balanced style.



DIM. (mm)	PINE	PRICE
800x600	D4RA6080P	€ 21,80
600x450	D4RA4560P	€ 14,40

CHALK AND
SPONGE
INCLUDED

PICASSO

Rectangular classic menu board that matches tradition and modernity. Available in different sizes, it has been projected to create a collage of boards to be broken up and re-created as a Cubist picture.



DIM. (mm)	BLACK	PRICE
300x900	D4PI3090X	€ 26,60
400x600	D4PI4060X	€ 22,80

CHALK AND
SPONGE
INCLUDED





SHAPE

OUTDOOR BLACKBOARD in painted MDF

Shape blackboards, with their clean and functional design, are best integrated in any type of place. Available in different sizes, with rounded corners to resist shocks and a large hole for easy hanging.

Hole 30 mm
to be easily
hanged

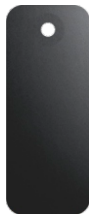

20 x 50 cm
LANESH_KL2050
€ 17,24

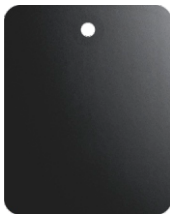

40 x 50 cm
LANESH_KL4050
€ 22,60



45 x 70 cm
LANESH_KL4570
€ 27,84

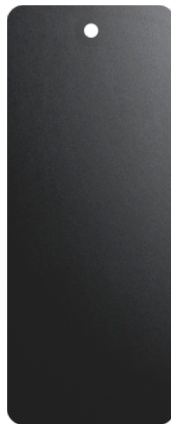

40 x 100 cm
LANESH_KL4010
€ 33,28

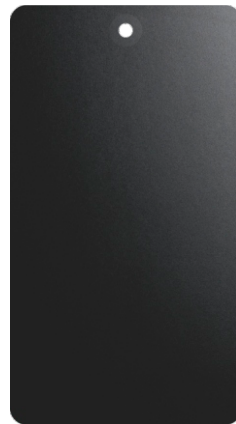

55 x 100 cm
LANESH_KL5510
€ 38,48



40 x 150 cm
LANESH_KL4015
€ 43,40

MARKERS

WHITE BIG X6 pz.	PE00C10	€ 48,00
WHITE X6 pz.	PE00C0	€ 17,40
LIGHT BLUE X6 pz.	PE00C1	€ 17,40
FUXIA X6 pz.	PE00C2	€ 17,40
YELLOW X6 pz.	PE00C3	€ 17,40



DEHOR

EASEL
in treated natural wood

Moisture resistant stand in natural wood (fir) with an essential design. Foldable and easily transportable, they adapt to any place. With adequate maintenance to the wood, they are particularly resistant.

30 x 115 cm
2 SIDES
CAV115
€ 79.00



30 x 165 cm
1 SIDE
CAV000
€ 79.00



43 x 165 cm
2 SIDES
CAV1643
€ 99.00



HOOK

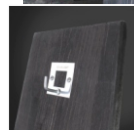



DALÍ

With a classic design, DAG offers the DALÍ model, a result of particularly strict tests that make the easel wind-resistant and, with adequate maintenance to the wood, even to wear.

**BLACKBOARD
TWO SIDES
OUTDOOR
in treated wood
Brown color**



MODEL (mm)	CODE	PRICE
450x900 (blackboard 450x600)	D4DA4590Z	€ 97,00
600x1200 (blackboard 600x900)	D4DA6012Z	€ 130,00

MODIGLIANI

Base in pine wood, natural color and board in painted MDF, ideal for bringing out menu suggestions or as a table sign.



TABLE BLACKBOARD
DOUBLE



21 x 29



15 x 21

CHALK AND
SPONGE
INCLUDED



5,5 x 6,5



8 x 15

MOD. (cm)	CODE	PRICE
5,5 x 6,5	D4SU00	€ 4,90
8 x 15	D4SU01	€ 6,90
21 x 29	D4MDA4	€ 8,90
15 x 21	D4MDA5	€ 5,90
DOUBLE	D4MD00	€ 9,90



ORDER HOLDER **EASY**

REAL BONDED LEATHER TH. 3,5



11x21 cm

cod. F3CO3Z
€ 10,56

Support with spring to hold blocks for orders or block notes. Base in regenerated leather 3.5 mm thick and brown ballpoint insert.

BILL HOLDER **LIGHT**

REAL BONDED LEATHER TH. 1,2



18x10 cm

cod. F3PS3Z
€ 9,63

Bill holder in brown bonded leather. The lapel allows you to lock the upper cover and to receive the coins back.

BILL HOLDER WALLET

REAL BONDED LEATHER TH. 0,8



18,7x11,2 cm

CUSTOMIZABLE

cod. F3WA3Z
€ 16,65

Brown bonded leather case to deliver the bill and collect the money in the form of banknotes, coins and credit card. Elastic closure. Possible customization on the cover.

BILL HOLDER POCKET

REAL BONDED LEATHER TH. 3,5



13,5x20 cm

CUSTOMIZABLE

cod. EMPK3N
€ 14,49

Support in 3.5 mm thick bonded leather to deliver the bill to the table with a credit card pocket and pen holder for signatures. Possible customization.

NAPKIN RING

REAL BONDED LEATHER TH. 1,2



€ 3,59/pc.

€ 17,95/box 5 pcs.

cod. F3PT3Z

Napkin ring with button in real bonded brown leather. Can also be used as a menu sheet holder.

TABLE SIGN

REAL BONDED LEATHER TH. 1,2



NUMBERS FOR TABLE SIGN

box 10 pcs. € 2,17

NUMRISE "reserved"
NUMSP01 from 1 to 10
NUMSP02 from 11 to 20
NUMSP03 from 21 to 30
NUMSP04 from 31 to 40
NUMSP05 from 41 to 50
NUMSP06 from 51 to 60
NUMSP07 from 61 to 70
NUMSP08 from 71 to 80
NUMSP09 from 81 to 90
NUMSP10 from 91 to 100

€ 3,48/pc.

€ 34,80/box 10 pcs.

cod. F3SP3Z

Table sign to compose in real bonded brown leather. Super resistant and stackable when not in use, also ideal for marking the table "reserved".

MINIMENU

REAL BONDED LEATHER TH. 1,2

CUSTOMIZABLE



€ 5,13/pc.

€ 25,65/box 5 pcs.

cod. F3MMCZ

Menu holder in real bonded brown leather made to hold a single sheet. Recommended for daily menus or receptions. Possible customization of the label.

REAL BONDED LEATHER



Bonded leather is made up of natural raw materials: 65% from genuine leather scraps tanned with vegetable substances, 18% from natural latex, 10% from water, 5% from natural fats and 2% from natural coloring agents.

MATERIALS & COLORS:

JUTE line th. 2,5 antibacterial PVC

Made in Italy PVC, with antibacterial certification. Printed with a JUTA effect texture for a pleasant feel to the touch and with an internal synthetic mesh that gives it considerable wearresistance over time.

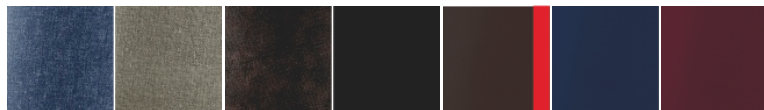

jute
JEANS

jute
GREY

jute
BROWN

jute
BLACK

jute
BICOLOR

jute
BLUE

jute
BURGUNDY

On light colors, particularly coloring substances can in some cases leave halos.

CHEF line th. 1,2 real bonded leather anti-stain

Light and flexible material and soft to the touch. Made from natural raw materials with stain protection. Strictly certified and ecological, it is at the top for strength and durability.

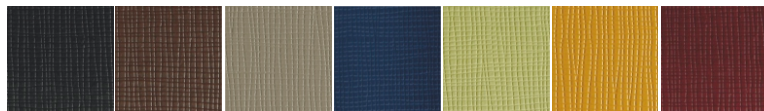

chef
BLACK

chef
BROWN

chef
GREY

chef
BLUE

chef
SAGE

chef
OCHER

chef
BURGUNDY

PLACEMATS



	JUTE	CHEF
21x32 cm	€ 5,14/pc.	€ 8,77/pc.
23x35 cm	€ 5,85/pc.	€ 10,15/pc.
32x32 cm	€ 7,33/pc.	€ 13,07/pc.
30x40 cm	€ 8,51/pc.	€ 15,40/pc.
30x45 cm	€ 9,30/pc.	€ 16,96/pc.
deskpad		
45x45 cm	€ 9,30/pc.	€ 16,96/pc.

PLACEMAT DROP



30x37.7 cm

JUTE
€ 8,51/pc.

CHEF
€ 15,40/pc.

ROUND PLACEMATS



Ø34 cm

JUTE
€ 7,87/pc.

CHEF
€ 14,13/pc.

CUTLERY REST



10x26 cm

JUTE
€ 2,88/pc.

CHEF
€ 4,32/pc.

OVAL PLACEMATS



JUTE
20x30 cm € 4,79/pc.
30x47 cm € 9,30/pc.

CHEF
20x30 cm € 8,07/pc.
30x47 cm € 16,96/pc.

COASTERS



Ø10 cm

JUTE
€ 1,97/pc.

CHEF
€ 2,52/pc.



9,5x9,5 cm

JUTE
€ 1,91/pc.

CHEF
€ 2,40/pc.

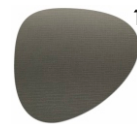

11x12 cm

JUTE
€ 2,40/pc.

CHEF
€ 3,17/pc.



real bonded
leather
color **black**
thickness

3.5

smooth
finish

MINI MENU 3.5



ø 6 cm
cod. F2MMCRE
€ 5,76

NAPKIN RING 3.5



6x7 cm
cod. F2PT3R
€ 4,00

TABLE SIGN ROLL 3.5



cod. F2STCR
€ 8,72 each

MENU COVER FRAME 3.5



cod. F2FR3R
€ 16,26

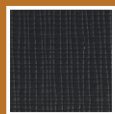

real bonded
leather
color **black**
thickness

1.2

CHEF
material

PORTFOLIO CLIP BOARD



size: A4

cod.
F3CN3XEN
€ 26,06

MENU NOTEPAD



size: A4
cod.
F3BL3XN
€ 23,91

size: A5
cod.
F3BL4XN
€ 18,04

CITY NOTEPAD



size: A4

cod.
F3CI3XM
€ 28,00

PLACEMATS
3.5



21x32 cm € 11,28
cod. F2T53R

23x35 cm € 13,13
cod. F2T93R

32x32 cm € 17,04
cod. F2T103R

30x40 cm € 20,17
cod. F2T83R

30x45 cm € 22,25
cod. F2TS3R

deskpad

45x45 cm € 22,25
cod. F2CT3R

DESKPAD
3.5



35x52 cm
cod. F2SM3R
€ 32,68

35x60 cm
cod. F2SM3R-2
€ 32,68

OVAL PLACEMATS
3.5



30x47 cm
cod. F2TE3R
€ 22,25

20x30 cm
cod. F2TF3R
€ 10,34

ROUND
PLACEMATS
3.5

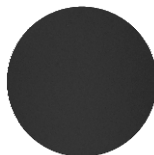

ø 34 cm
cod. F2SO3R
€ 18,46

COASTERS
3.5



ø 10 cm
cod. F2SB3R
€ 2,89

COASTERS
3.5



9.5x9.5 cm
cod. F2SQ3R
€ 2,74

CUTLERY
REST
3.5



10x26 cm
cod. F2PP3R
€ 5,31



Accessories in real bonded leather 3.5 mm thick already used for making belts.

Coordinates designed to offer maximum resistance with a minimal and prestigious design.

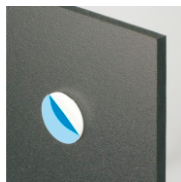

included double-stickers

The DAG Style pictograms in PVC, 5 mm thick, are equipped with high-strength double-sided stickers, suitable for application on "compact" surfaces.

The white color serigraphs on a black base make them perfect for all types of places.

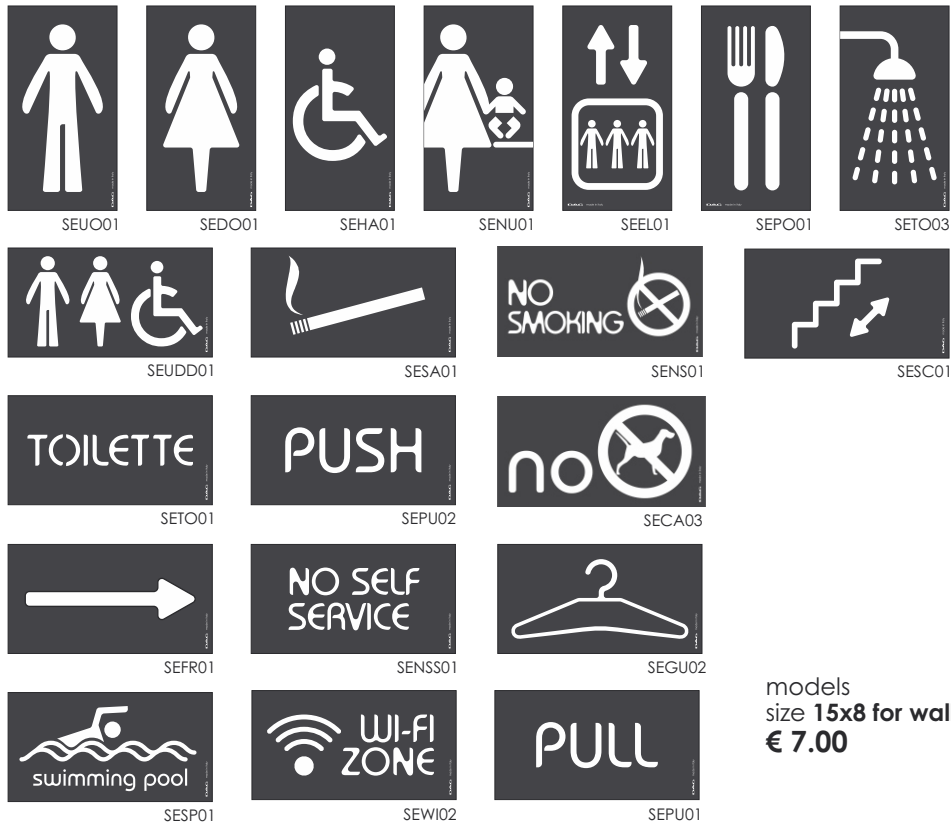

models
size 15x8 for wall
€ 7.00



SP0002



SENS02

models
size **5,5x7,5**
for the table
€ 8,97



SER102

model
size **15x8**
for the table
€ 10,29



SEGR01

model
"BENVENUTI"
size **15x21**
€ 9.00



DAG made in Italy

MENU COVERS

		STANDARD NUMBER OF ENVELOPES	NUMBER OF SIDES	MAXIMUM NUMBER OF ENVELOPES	ANTI-STAIN TREATMENT	WASHABILITY from 0 to 100	MECHANICAL STRENGTH from 0 to 100	LIGHT RESISTANCE from 0 to 100	SUSTAINABILITY from 0 to 100	PERSONALIZATION
page 6	MENU CUSTOM	2	4	8	NO	79	50	80	98	ON THE COVER
page 12	MENU ECOMODA	4	8	10	NO	90	70	85	99	ONLY LABEL
page 16	MENU JUTE	4	8	16	NO	90	95	90	50	ONLY LABEL
page 20	MENU CHEF	4	8	16	SI	99	90	99	97	ONLY LABEL
page 24-26	MENU CORK (NAT - COL)	4	8	16	NO	90	85	60	98	ONLY LABEL
page 28	MENU VINTAGE	4	8	16	NO	90	50	70	98	ONLY LABEL
page 30	MENU NOTEPAD	0	0	0	SI	99	99	99	99	ONLY LABEL

ORDER SUMMARY

Order Number

Date

Agent

Name of Company

Road

N.

Postal code

Village

Province

Tel.

Mobile

Email

VAT

Fiscal Code

Model/Item	Color	Q.ty	Price	Amount

Transpor
cost

Total Order

stamp and signature





DAG Style s.r.l.

Via Manzoni, 18 | 25020 Flero (BS) | ITALY
Ph. +39 030 2680315 | Fax +39 030 2680525

www.dagstyle.it

DAG®
style



telephon:
+39 030 2680315



e-mail:
info@dagstyle.it



whatsapp:
+39 392 4389027



chat:
www.dagstyle.it

